

VVS 186193-340

Jotiflex bøjning, trinløs fra 0-90° Ø40 1 muffe hvid, graderne 15,30,45,60 og 90 er markeret på bøjningen. VA-Godkendt.



## Specifikationer

<b>VVS nummer</b>	186193-340
<b>Materiale</b>	Plast (PP)
<b>Udtag Dimension</b>	Ø40 mm
<b>Vare farve</b>	Hvid
<b>Version</b>	Flexibel



Ø 32/40/50/75/110 mm

0 - 90°

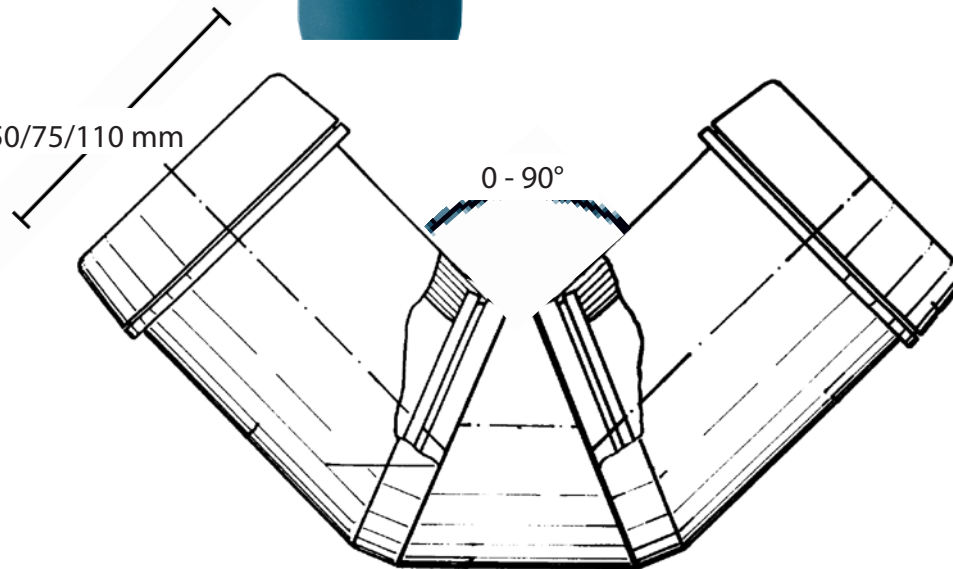

muffe + 1 spids

VVS nr.	Dim/mm
186193-032	32
186193-040	40
186193-050	50
186193-075	75
186193-110	110

muffe + muffe

VVS nr.	Dim/mm
186194-032	32
186194-040	40
186194-050	50
186194-075	75
186194-110	110



**PURUS.dk**  
- Leverandør af stærke VVS-løsninger

Projekt nr	Tegning nr. 18193-032/040/050/075/110 186194-032/040/050/075/110_1	A4	Ytbehandling	Denne erstatter tegning nr.	Dato
<b>PURUS</b> Purus AS Farum Gydevej 71 3520 FARUM Tel 4616 1919 Fax 4616 1910 www.purus.dk	Skala	Sider 1	Generell tolerans. ISO 2768-1	Vægt (gram)	Volumen (cm <sup>3</sup> )
	Materiale PP	Varenavn PURUS Jotiflex rørbøjninger	VVS nr 18193-032/040/050/075/110 186194-032/040/050/075/110	Godkend. sign. GUF	Dato 24/10/14
				Forfatter GUF	Oprettelses dato 24/10/14
				Artikel nr 186193-xxx + 186194-xxx	Udgave 1